



CEILING CASSETTE

Midea Aircon Catalogue



YEARS COMPRESSOR
WARRANTY

*Applicable for residential
aircon only

First 2 Years
General On Site Warranty

Peace of Mind



Prime Guard
Golden Fin



LED Display



Fast Cooling

OUR STORY SO FAR

Carved from 50 years of experience

Midea, established in 1968, is a publicly listed company and since July 2016, a **Fortune 500 company** offering one of the most comprehensive ranges in the home appliances industry. Midea specialises in air treatment (residential and commercial solutions), refrigeration, laundry, cooking appliances, small kitchen appliances, water appliances, floor care and lighting.

More than
\$36 Bn*
of revenue in
2017
*in RMB

Serve
customers in
200+
countries

32
global
production
facilities

136,800
employees
worldwide

Global Fortune
500
company



INTERNATIONAL DESIGN EXCELLENCE AWARDS

CB CE



FORTUNE
GLOBAL
500
2021

www.midea.com/global

www.midea.com.sg

Unit Lineup







Single Split Cassette



Capacity		18K	24K	36K	45K	48K (3-Ph)	55K (3-Ph)
4-way Cassette (R32)	Indoor	MCD18-HRFN32 	MCD24-HRFN32 	MCD36-HRFN32 	MCD45-HRFN32 	MCD48-3HRFN32 	MCD55-3HRFN32 
	Outdoor	MOU18-HVN32 	MOU24-HVN32 	MOU36-HVN32 	MOU45-HVN32 	MOU48-3HVN32 	MOU55-3HVN32 
	Tick Rating	 Fair Annual Energy Cost: \$757 Annual Energy Consumption: 2803 kWh Midea Split type (Inverter) Air-conditioner MOU18-HVN32 Cooling Capacity: 1.8 kW	 Good Annual Energy Cost: \$885 Annual Energy Consumption: 3276 kWh Midea Split type (Inverter) Air-conditioner MOU24-HVN32 Cooling Capacity: 2.4 kW	 Fair Annual Energy Cost: \$1219 Annual Energy Consumption: 4514 kWh Midea Split type (Inverter) Air-conditioner MOU36-HVN32 Cooling Capacity: 3.4 kW	 Fair Annual Energy Cost: \$1462 Annual Energy Consumption: 5414 kWh Midea Split type (Inverter) Air-conditioner MOU45-HVN32 Cooling Capacity: 4.5 kW	N.A.	N.A.

Mini VRF Cassette

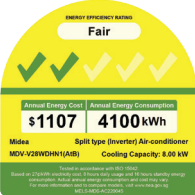
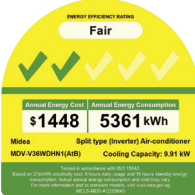
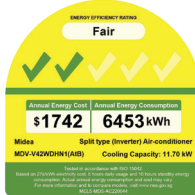

Capacity		28K	36K	42K
4-Way Cassette (R410A) Mini VRF	Indoor	MDV-D28Q4/N1-E(At) 	MDV-D36Q4/N1-E(At) 	MDV-D48Q4/N1-E(At) 
	Outdoor	MDV-V28WDHN1(AtB) 	MDV-V36WDHN1(AtB) 	MDV-V42WDHN1(AtB) 
	Tick Rating	 Fair Annual Energy Cost: \$1107 Annual Energy Consumption: 4100 kWh Midea Split type (Inverter) Air-conditioner MDV-V28WDHN1(AtB) Cooling Capacity: 8.00 kW	 Fair Annual Energy Cost: \$1448 Annual Energy Consumption: 5361 kWh Midea Split type (Inverter) Air-conditioner MDV-V36WDHN1(AtB) Cooling Capacity: 9.91 kW	 Fair Annual Energy Cost: \$1742 Annual Energy Consumption: 6453 kWh Midea Split type (Inverter) Air-conditioner MDV-V42WDHN1(AtB) Cooling Capacity: 11.76 kW

Real Convenience Without Compromise

Power Breezeless Technology

Meet the various and individual cooling requirements to achieve real comfort for everyone

Exclusive power breezeless wind deflector contains over 3920 micro-holes. Each hole is in hourglass shaped to boost then disperse the air stream as it funnels through all the micro-holes are distributed in different direction and size together turning the strong blast into cool and billowing mist.

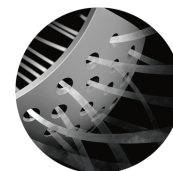

3920 MICRO HOLES
in different size and directions

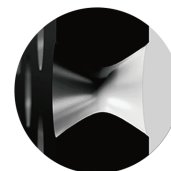

**HOURGLASS-SHAPED
HOURGLASS-SHAPED MICRO
HOLES**

Compress then emitted the across
air stream

Individual Vane Control

The individual vane control system enables the unit to supply multi-directional airflow and customize everyone's comfort with a multitude of cooling configurations.

4 possible cooling
experience in
1 occasion.



Real Convenience Without Compromise

360° Round Flow

Unique seamless airflow louver design allows cool air to diffuse and sink in 360° offering uniform cooling experience throughout the space.



Adjustable Vane and Long Airflow

Adjustable vane from 0 to 75 and 5.5 meters long airflow, no corner in your room is beyond its reach



Real Convenience Without Hassle

LED Display

Larger LED Display design and it is easier to check the temperature at any time. Get rid of control trouble through wired and wireless controllers.

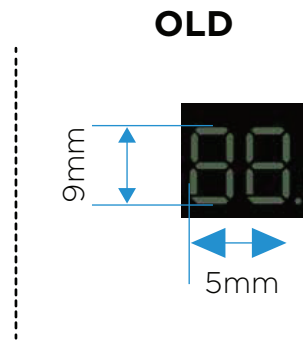
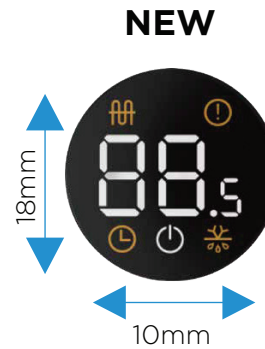

Controller

Build-in Infrared receiver



Wireless Controller
RG10B



Wired Controller
RG10N3(2HS)/BGEF

An infrared receiver is built in the wired controller. It is more convenient for users to control the AC with the wireless controller by pointing to the wired controller rather than to the AC.

Reserved Air Outlet for Duct

Reserves the space for air outlet from the side of indoor unit. It's available to connect air duct from side to small rooms nearby.

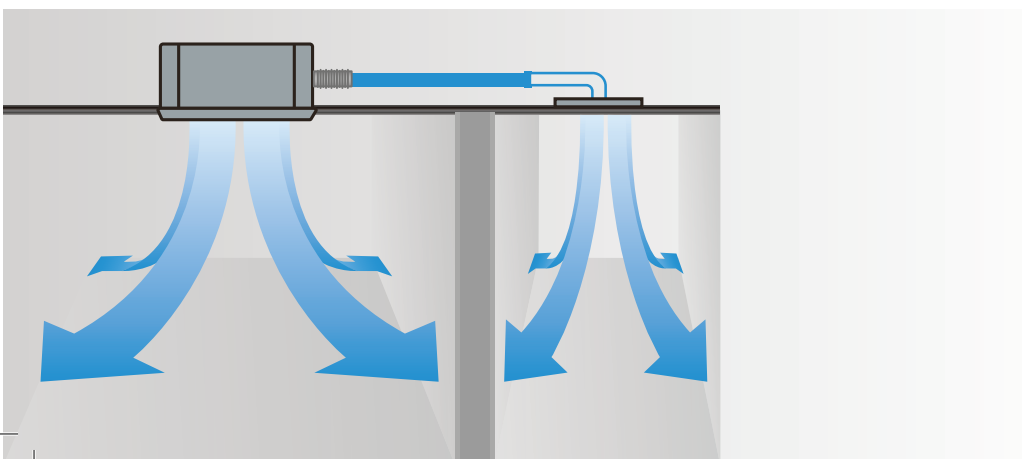

Real Health Without Concerns

Fresh Air

Outdoor air can be led into the room via a connection pipe, which keeps the indoor air fresh and healthy.

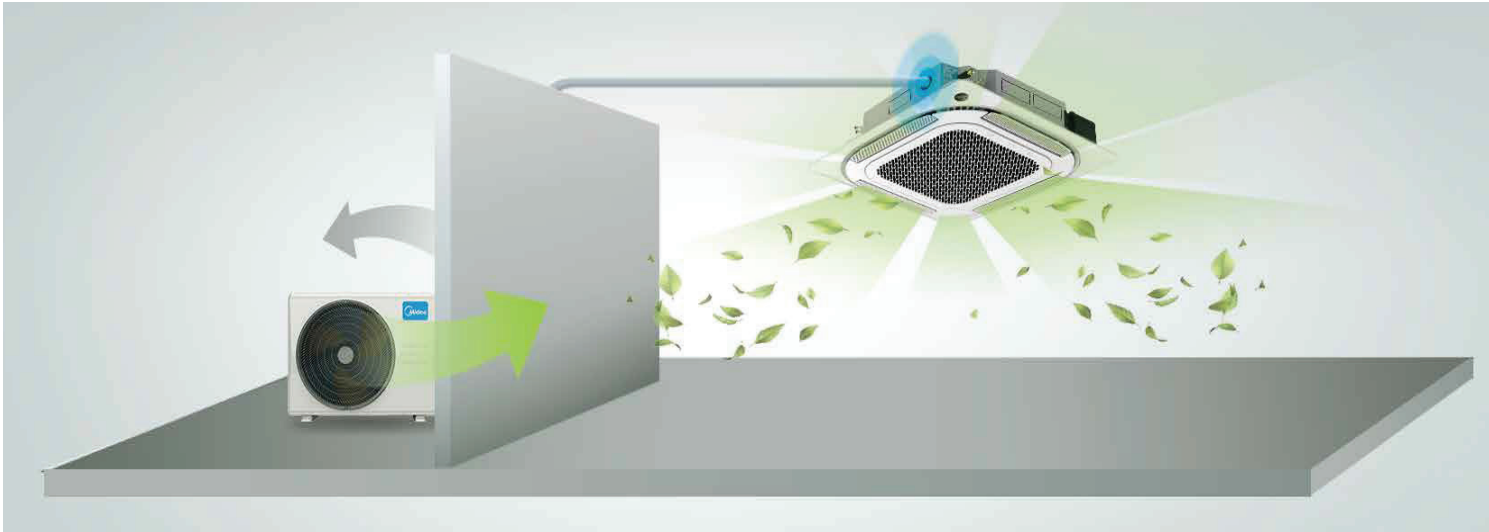

Filtration System

Eliminate harmful substances in two successive steps and provide fresh and clean air for you

Full High Density Filter

Blocks out dust particles and other airborne impurities as initial screening.

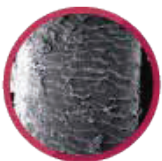

Dog hair



Dead Mite feces



Fungus



Rotation: Intelligent Dusting Switch

After turning off the aircon, the fan blade of the outdoor unit will automatically rotate in reverse to get rid of the sand and dust to keep the aircon clean.



*1 phase DC Inverter outdoor unit only

Stay Cool, Green and Energy Efficient

GA Algorithm

The GA inverter technology is advanced control program of compressor operation frequency with 0.6Hz adjustment precision and faster startup. It facilitates better temperature experience and ensure fast frequency increase during startup, stable operation in hard condition and accurate output to temperature change.

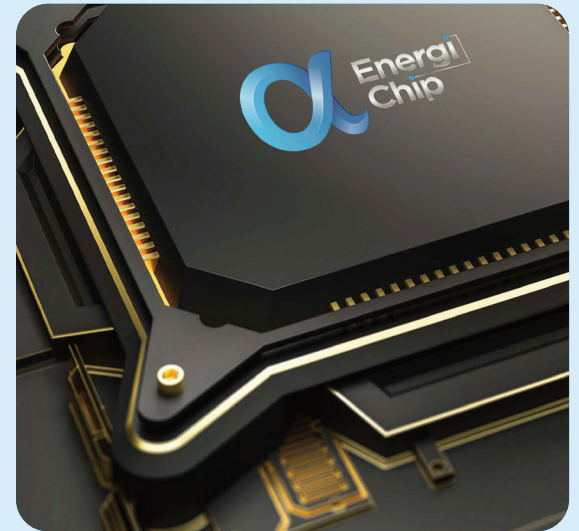

Ordinary Inverter Mode

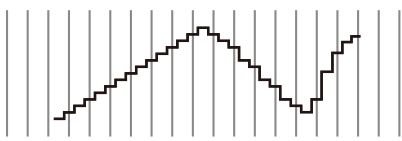

Precise - Control Algorithm Inverter Mode

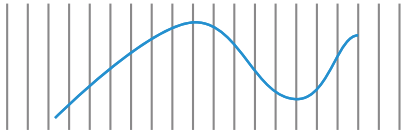

Temperature Graph

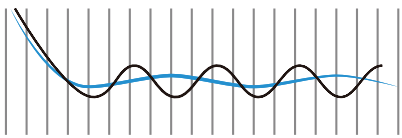

— Precise - Control Algorithm Inverter Mode
— Ordinary Inverter Mode

Inverter Quattro



The exclusive Midea Inverter Quattro technology empowers Midea's inverter compressor to be one of the best AC compressors in the world. Under all conditions, Midea inverter compressors operate powerfully, efficiently, speedily and steadily at the same time.

iECO Mode



One click to lit the maximum frequency current while still maintain the room temperature within the optimal temperature, guarantee the comfortable coolness while significantly reducing energy consumption. As little as 1.36 kWh per night in the ECO mode over 8 hours.

*The results is tested under the specified working conditions, the indoor side dry bulb temperature at 31 degrees with relative humidity at 50%, the outer dry bulb temperature at 40 degrees and the relative humidity at 50%.

**Worry Free &
Guaranteed for life**

Prime Guard, Golden Coating

Midea PrimeGuard is more resistant in oxidation & corrosion than ordinary fins for condensers to furnish a steadier and long-lasting working environment. It can efficiently prevent bacteria from breeding and spreading and withstand corrosive elements.

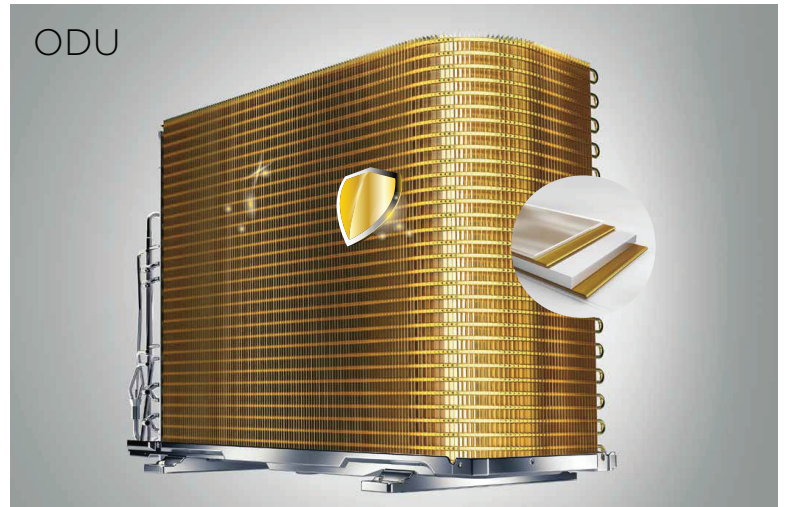
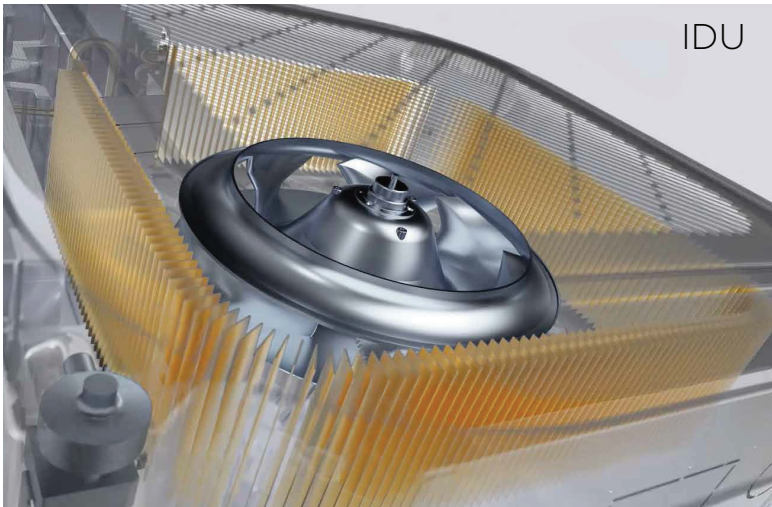

Comparison Result of Corrosion Area*

Golden Coating is 2.5X corrosion resistance than blue coating

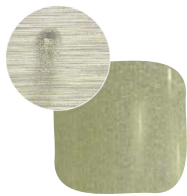

Golden Coating
0.10%



Blue Coating
0.25%



Aluminum Foil
100%

*After 240 hours UV test and 72 hours neutral salt spray (fog test)

Water Tray

The water tray is specially upgraded from anti-corrosion plastic material, increased thickness and optimized structure, assuring greater durability and longer product life.

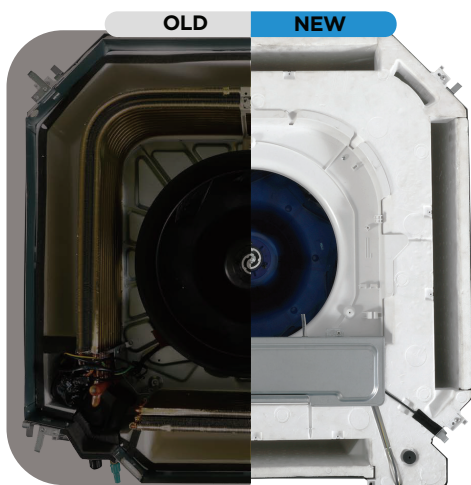

2.2mm
+120%

Due to 1.4mm ABS moulding enlargement, the durability of drainage tray will enhance to prevent damage.

Easy Installation & Maintenance

Super Slim Design

Midea Cassette is much slimmer, thanks to the redesigned heat exchanger and overall structure. It now requires less space for installation.

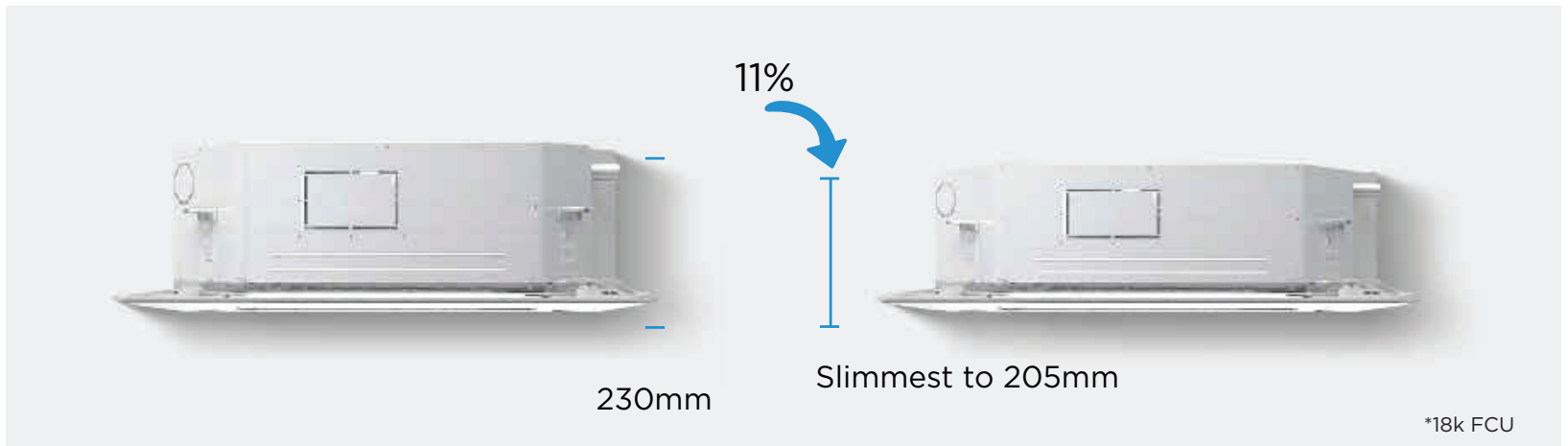

Re-structure Drain Pump

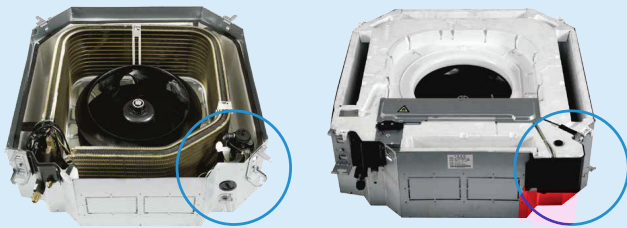

30 minutes faster for water pump maintenance

Thanks to the innovative windtrack design, the drain pump is placed outside the air channel, which means ultra easy access to drain pump that all you need is to remove the panel.



Lifting height up to 1000mm

Equipped with an external drain pump, Midea Cassette can lift the condensate water up to 1000mm, making the installation and the discharge of condensate water much easier.

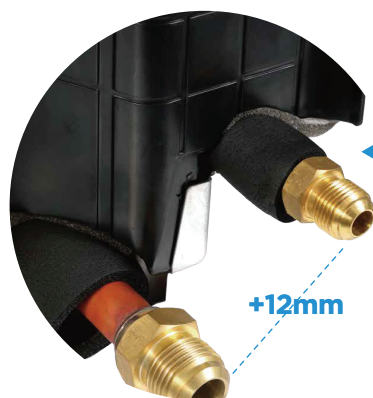

Enlarge Space For Piping

More friendly for handwork operation

User-friendly Hook Design



Curved metal hook with more ergonomic is easier to carry and uplift the machine.

Features & Functions

COMFORT



Follow Me

Temperature sensor built in the remote controller will sense its surrounding temperature. So the unit can adjust room temperature more accurately to give you comfort.



Flash Cooling

Press the boost button to let the room cool down rapidly



Anti-Cold Air Function

Indoor fan speed is regulated automatically from the lowest grade to the setting grade according to evaporator temperature when the unit just starts heating operation. This function can prevent cold air blowing out to avoid discomfort to the users.



Sleep Mode

The function enables the air conditioner to automatically increase cooling or decrease heating 1°C per hour for the first 2 hours, then holds steady for the next 5 hours, after that it will switch off. This function maintains both energy saving and comfort at night.



Dry Mode

Dry mode eliminates the humidity in the air by acting as a dehumidifier, which can easily remove moisture from the indoor air. This feature is very useful during the seasons, in which there is more rain and moisture outside.

HEALTH



Rotation: Intelligent Dusting Switch

1-phase DC inverter outdoor unit only

CONVENIENCE



Power Down Memory

Revert back to last settings in the event of power outage.



Timer

Set the unit to start and stop automatically in a 24 hour period.



Auto Restart Function

If the air conditioner breaks off unexpectedly due to the power cut, it will restart with the previous setting mode automatically when the power resume.



Refrigerant Leakage Detect

Indoor unit will show error code "EC" and stop automatically when refrigerant leakage is detected. This function can better protect compressor being damaged by high temperature due to refrigerant leakage.

RELIABILITY



Emergency Using Function

When temperature sensor error happens, the air conditioner will display error code and stop immediately, while Midea AC will display error and continue running in a proper status, to avoid the case that AC is in urgent need.

Specifications

Single Split Cassette



Midea Ceiling Cassette								
		Model						
Indoor		MCD18-HRFN32	MCD24-HRFN32	MCD36-HRFN32	MCD45-HRFN32	MCD48-3HRFN32	MCD55-3HRFN32	
Outdoor		MOU18-HVN32	MOU24-HVN32	MOU36-HVN32	MOU45-HVN32	MOU48-3HVN32	MOU55-3HVN32	
Power Supply	V-Ph-Hz	220-240V / 1Ph / 50Hz				380-415V / 3Ph / 50Hz		
Capacity	Btu/h	18084 (11263-27000)	23679 (7600-32000)	30000 (12280-44800)	36000 (18580-54900)	48000 (12000-54000)	52000 (14000-57000)	
Input	W	1520.00	1800.00	2207.00	2600.00	4650.00	5000.00	
EER	W/W	3.50	3.90	4.00	4.10	3.03	3.05	
Max. Input Consumption	W	3700	4500	7000	7000	6900	7500	
Max. Current	A	19.0	20.0	31.0	31.0	13.0	14.0	
Indoor Air Flow (H / M / L)	m ³ /h	1247 / 1118 / 992	1700 / 1530 / 1300	1818 / 1651 / 1259	1818 / 1651 / 1259	1900 / 1750 / 1600	2000 / 1850 / 1650	
Indoor Sound Level (H / M / L)	dB(A)	50.0 / 47.5 / 42.0	50.5 / 48.0 / 46.0	54.0 / 49.0 / 46.0	54.0 / 49.0 / 46.0	52.5 / 50.5 / 48.0	54.5 / 52.0 / 49.5	
Indoor Unit	Panel Dimension (W x D x H)	mm	950 x 950 x 55	950 x 950 x 55	950 x 950 x 55	950 x 950 x 55	950 x 950 x 55	
	Panel Packing (W x D x H)	mm	1035 x 1035 x 90	1035 x 1035 x 90	1035 x 1035 x 90	1035 x 1035 x 90	1035 x 1035 x 90	
	Panel Net / Gross Weight	Kg	6.0 / 9.0	6.0 / 9.0	6.0 / 9.0	6.0 / 9.0	6.0 / 9.0	
	Unit Dimension (W x D x H)	mm	830 x 830 x 205	830 x 830 x 245	830 x 830 x 287	830 x 830 x 287	830 x 830 x 287	830 x 830 x 287
	Unit Packing (W x D x H)	mm	910 x 910 x 250	910 x 910 x 290	910 x 910 x 330	910 x 910 x 330	910 x 910 x 330	910 x 910 x 330
	Unit Net / Gross Weight	Kg	21.6 / 25.4	24.6 / 28.6	29.3 / 34.3	29.3 / 34.3	29.3 / 33.5	29.3 / 33.5
Outdoor Sound Level	dB(A)	60.0	62.0	60.0	60.0	63.5	64.0	
Outdoor Unit	Dimension (W x D x H)	mm	890 x 342 x 673	946 x 410 x 810	952 x 415 x 1333	952 x 415 x 1333	952 x 415 x 1333	952 x 415 x 1333
	Packing (W x D x H)	mm	995 x 398 x 740	1090 x 500 x 885	1095 x 495 x 1480	1095 x 495 x 1480	1095 x 495 x 1480	1095 x 495 x 1480
	Net / Gross Weight	Kg	43.9 / 46.9	52.8 / 57.3	95.1 / 109.2	95.1 / 109.2	103.7 / 118.3	107.0 / 121.2
Refrigerant Type	Kg	R32 / 1.50	R32 / 2.0	R32 / 3.60	R32 / 3.60	R32 / 2.90	R32 / 3.00	
Piping	Liquid / Gas	mm	9.52 / 15.88	9.52 / 15.88	9.52 / 15.88	9.52 / 15.88	9.52 / 15.88	9.52 / 15.88
		inch	3/8" / 5/8"	3/8" / 5/8"	3/8" / 5/8"	3/8" / 5/8"	3/8" / 5/8"	3/8" / 5/8"
	Max. Length	m	50	50	75	75	75	75
	Max. Height	m	25	25	30	30	30	30
Drain	mm	18	18	18	18	18	18	
Operation temperature	°C	17~30						
Energy Labelling Scheme						N.A	N.A	

Remark:

1. Cooling: indoor temperature 27 °C DB/19 WB and outdoor temperature 35 °C DB/24 WB.
2. All the product design and specifications are subject to change without prior notice.

Specifications

Mini VRF Cassette

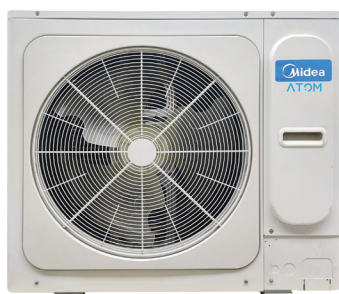

		Model				
Indoor		MDV-D28Q4/N1-E(At)	MDV-D36Q4/N1-E(At)	MDV-D48Q4/N1-E(At)		
Outdoor		MDV-V28WDHN1(AtB)	MDV-V36WDHN1(AtB)	MDV-V42WDHN1(AtB)		
Power Supply	V-Ph-Hz	220-240V / 1Ph / 50Hz				
Capacity	Btu/h	27296 (13648-28660)	34120 (17060-35826)	40944 (20472-42991)		
Input	W	2100	2660	3310		
EER	W/W	3.81	3.76	3.63		
Max. Input Consumption	W	2310	2865	3476		
Max. Current	A	21.0	29.0	35.0		
Indoor Air Flow (H / M / L)	m3/h	1200 / 1021 / 789	1651 / 1304 / 1127	1658 / 1335 / 1130		
Indoor Sound Level (H / M / L)	dB(A)	42.0 / 39.0 / 37.0	45.0 / 42.0 / 40.0	46.0 / 41.0 / 39.0		
Indoor Unit	Panel Dimension (W x D x H)	mm	950 x 950 x 50	950 x 950 x 50	950 x 950 x 50	
	Panel Packing (W x D x H)	mm	1035 x 1035 x 90	1035 x 1035 x 90	1035 x 1035 x 90	
	Panel Net / Gross Weight	Kg	5.8 / 7.9	5.8 / 7.9	5.8 / 7.9	
	Unit Dimension (W x D x H)	mm	840 x 840 x 230	840 x 840 x 300	840 x 840 x 300	
	Unit Packing (W x D x H)	mm	955 x 955 x 260	955 x 955 x 330	955 x 955 x 330	
	Unit Net / Gross Weight	Kg	23.7 / 28.9	28.7 / 34.1	30.9 / 36.3	
Outdoor Sound Level	dB(A)	54.0	54.0	56.0		
Outdoor Unit	Dimension (W x D x H)	mm	910 x 426 x 712	950 x 440 x 840	951 x 440 x 840	
	Packing (W x D x H)	mm	1045 x 485 x 810	1025 x 510 x 950	1026 x 510 x 950	
	Net / Gross Weight	Kg	49 / 53	59.5 / 66.5	63 / 70	
Refrigerant Type	Kg	R410A / 1.7	R410A / 2.3	R410A / 2.4		
Piping	Liquid / Gas	mm	9.52 / 15.88	9.52 / 15.88	9.52 / 15.88	
		inch	3/8" / 5/8"	3/8" / 5/8"	3/8" / 5/8"	
	Max. Length	m	35	45	45	
	Max. Height	m	10	20	20	
Drain	mm	19	19	19		
Operation temperature	°C	17~30				
Energy Labelling Scheme						

Remark:

1. Cooling: indoor temperature 27°C DB/19 WB and outdoor temperature 35°C DB/24 WB.
2. All the product design and specifications are subject to change without prior notice.

Mini VRF Cassette



AIR FLOW

360 degree Airflow

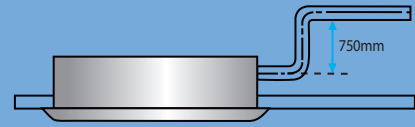

New design, round airflow path ensures uniform air flow and temperature distribution



HIGH LIFT DRAIN PUMP

A drain pump with a 750m raise height is fitted as standard, simplifying installation of the drain piping.

Controller Features

Model	 RM05B(A)	 WDC-86E/KD
On / Off	●	●
Mode selection	●	●
Temperature setting	● (0.5°C or 1°C steps)	● (0.5°C or 1°C steps)
7-speed fan control	●	●
Auto swing	●	●
5-step swing louver	●	●
Address setting	●	●
Eco mode	●	●
Silent mode	●	●
Display shut-off	●	●
Daily timer	●	●
Background light	●	●
Dimensions (H×W×D) (mm)	150×65×20mm	86×86×20mm
Dual temperature set points	×	●
Room temperature display	×	●

Outdoor Dimensions

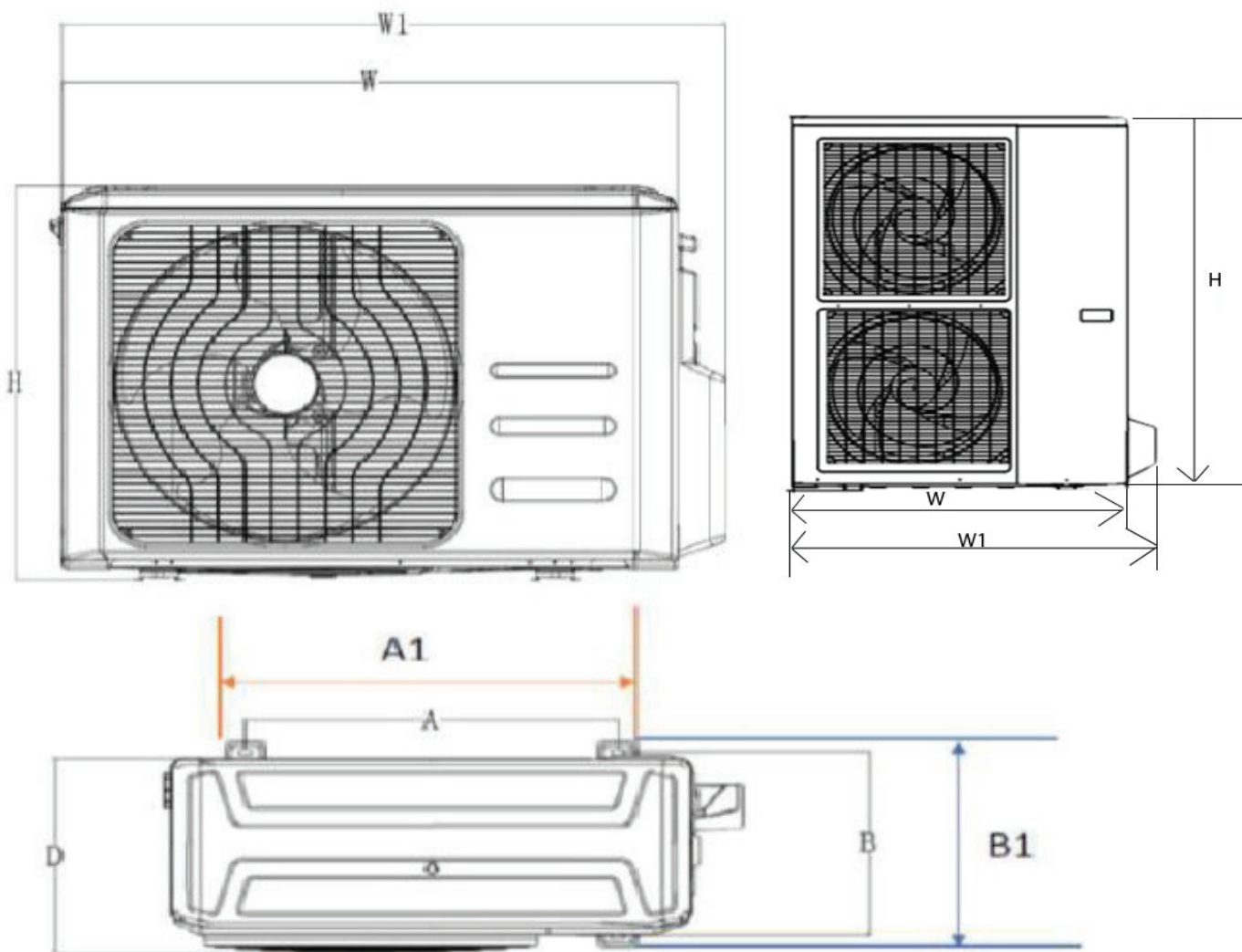

Model	Ticks	W	H	D	W1	A	A1	B	B1	Net W (Kg)
Cassette (R32)										
MOU18-HVN32	2	890	673	342	955	663	687	348	380	43.9
MOU24-HVN32	3	946	810	410	1030	673	692	403	455	52.8
MOU36-HVN32	2	952	1333	415	1045	634	664	404	457	95.1
MOU45-HVN32	2	952	1333	415	1045	634	664	404	457	95.1
MOU48-3HVN32	-	952	1333	415	1045	634	664	404	457	103.7
MOU55-3HVN32	-	952	1333	415	1045	634	664	404	457	107.0
Atom Series (R410A)										
MDV-V28WDHN1(AtB)	2	910	712	390	982	663	737	375	426	49.0
MDV-V36WDHN1(AtB)	2	950	840	406	-	590	678	390	440	59.5
MDV-V42WDHN1(AtB)	2	950	840	406	-	590	678	390	440	63.0



MD (SINGAPORE) Consumer Product Co. Pte Ltd

151 Lor Chuan, #04-05 (Lobby E), New Tech Park, Singapore 556741

Website: www.midea.com.sg

Customer Service Hotline: +65 6655 7666

Email: gmcs@midea.com



**Scan here to view
more at midea.sg**

Products specifications, designs and other contents featured in this brochure are as per on March 2023, but subjected to change without notice.